

## N-Channel Enhancement Mode Field Effect Transistor

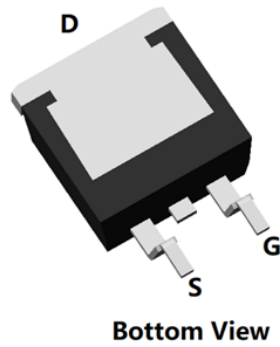

**TO-263**

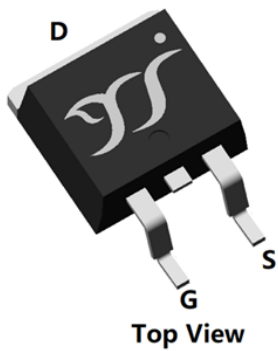
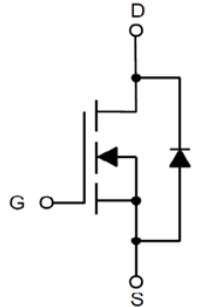

### Product Summary

- $V_{DS}$  800V
- $I_D$  17A
- $R_{DS(ON)}$  (at  $V_{GS}=10V$ )  $<290m\Omega$
- 100% EAS Tested
- 100%  $\nabla V_{DS}$  Tested

### General Description

- Super Junction High Voltage MOSFET technology
- Low Power Loss by High Speed Switching and Low On-Resistance
- Moisture Sensitivity Level 1
- Epoxy Meets UL 94 V-0 Flammability Rating
- Halogen Free

### Applications

- Power switching application
- Flyback power supply stages
- Adapter
- Lighting

### ■ Absolute Maximum Ratings ( $T_A=25^\circ C$ unless otherwise noted)

Parameter		Symbol	Limit	Unit
Drain-source Voltage		$V_{DS}$	800	V
Gate-source Voltage		$V_{GS}$	$\pm 30$	V
Drain Current	$T_A=25^\circ C$	$I_D$	2	A
	$T_A=100^\circ C$		1.3	
	$T_C=25^\circ C$		17	
	$T_C=100^\circ C$		10	
Pulsed Drain Current <sup>A</sup>		$I_{DM}$	50	A
Avalanche energy <sup>B</sup>		EAS	225	mJ
Total Power Dissipation <sup>C</sup>	$T_A=25^\circ C$	$P_D$	2.7	W
	$T_A=100^\circ C$		1	
	$T_C=25^\circ C$		200	
	$T_C=100^\circ C$		80	
Junction and Storage Temperature Range		$T_J, T_{STG}$	-55~+150	$^\circ C$

### ■ Thermal resistance

Parameter		Symbol	Typ	Max	Units
Thermal Resistance Junction-to-Ambient <sup>D</sup>	Steady-State	$R_{\theta JA}$	35	45	$^\circ C/W$
Thermal Resistance Junction-to-Case	Steady-State	$R_{\theta JC}$	0.5	0.62	

### ■ Ordering Information (Example)

PREFERRED P/N	PACKING CODE	Marking	MINIMUM PACKAGE(pcs)	INNER BOX QUANTITY(pcs)	OUTER CARTON QUANTITY(pcs)	DELIVERY MODE
YJB17C80HJ	F2	YJB17C80HJ	800	/	8000	13" reel



# YJB17C80HJ

## ■ Electrical Characteristics (T<sub>J</sub>=25°C unless otherwise noted)

Parameter	Symbol	Conditions	Min	Typ	Max	Units
<b>Static Parameter</b>						
Drain-Source Breakdown Voltage	BV <sub>DSS</sub>	V <sub>GS</sub> =0V, I <sub>D</sub> =250μA	800	-	-	V
Zero Gate Voltage Drain Current	I <sub>DSS</sub>	V <sub>DS</sub> =800V, V <sub>GS</sub> =0V	-	-	1	μA
		V <sub>DS</sub> =800V, V <sub>GS</sub> =0V, T <sub>J</sub> =150°C	-	-	100	
Gate-Body Leakage Current	I <sub>GSS</sub>	V <sub>GS</sub> = ±30V, V <sub>DS</sub> =0V	-	-	±100	nA
Gate Threshold Voltage	V <sub>GS(th)</sub>	V <sub>DS</sub> = V <sub>GS</sub> , I <sub>D</sub> =250μA	2	3	4	V
Static Drain-Source On-Resistance	R <sub>DS(on)</sub>	V <sub>GS</sub> =10V, I <sub>D</sub> =11A	-	220	290	mΩ
Diode Forward Voltage	V <sub>SD</sub>	I <sub>S</sub> =17A, V <sub>GS</sub> =0V	-	0.85	1.2	V
Gate resistance	R <sub>G</sub>	f=1MHz	-	2	-	Ω
Maximum Body-Diode Continuous Current	I <sub>S</sub>		-	-	17	A
<b>Dynamic Parameters</b>						
Input Capacitance	C <sub>iss</sub>	V <sub>DS</sub> =25V, V <sub>GS</sub> =0V, f=1MHz	-	1800	-	pF
Output Capacitance	C <sub>oss</sub>		-	1500	-	
Reverse Transfer Capacitance	C <sub>rss</sub>		-	64	-	
<b>Switching Parameters</b>						
Total Gate Charge	Q <sub>g</sub>	V <sub>GS</sub> =10V, V <sub>DS</sub> =640V, I <sub>D</sub> =17A	-	56	-	nC
Gate-Source Charge	Q <sub>gs</sub>		-	10	-	
Gate-Drain Charge	Q <sub>gd</sub>		-	22	-	
Reverse Recovery Charge	Q <sub>rr</sub>	I <sub>F</sub> =17A, di/dt=100A/us	-	9.5	-	nC
Reverse Recovery Time	t <sub>rr</sub>		-	565	-	ns
Turn-on Delay Time	t <sub>D(on)</sub>	V <sub>GS</sub> =10V, V <sub>DD</sub> =400V, I <sub>D</sub> =17A R <sub>GEN</sub> =25Ω	-	32	-	ns
Turn-on Rise Time	t <sub>r</sub>		-	56	-	
Turn-off Delay Time	t <sub>D(off)</sub>		-	160	-	
Turn-off fall Time	t <sub>f</sub>		-	49	-	

A. Repetitive rating; pulse width limited by max. junction temperature.

B. T<sub>J</sub>=25°C, V<sub>DD</sub>=50V, V<sub>G</sub>=10V, L=50mH, I<sub>AS</sub>=3A.

C. P<sub>d</sub> is based on max. junction temperature, using junction-case thermal resistance.

D. The value of R<sub>θJA</sub> is measured with the device mounted on 1 in<sup>2</sup> FR-4 board with 2oz. Copper, in the still air environment with T<sub>A</sub>=25°C.

The maximum allowed junction temperature of 150°C. The value in any given application depends on the user's specific board design.



# YJB17C80HJ

## Typical Electrical and Thermal Characteristics Diagrams

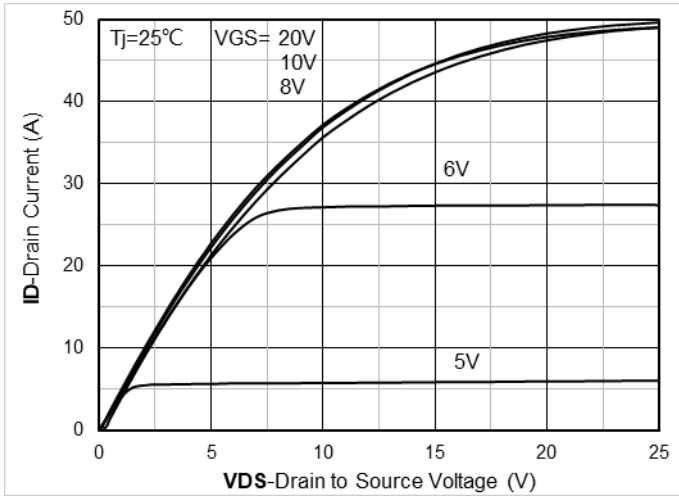

Figure1. Output Characteristics

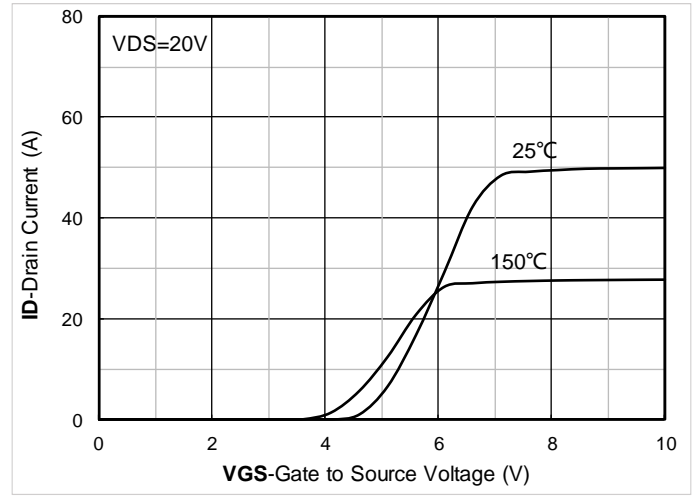

Figure2. Transfer Characteristics

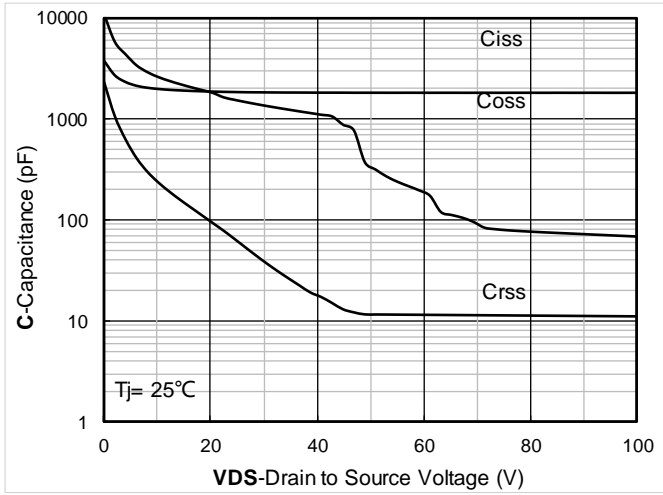

Figure3. Capacitance Characteristics

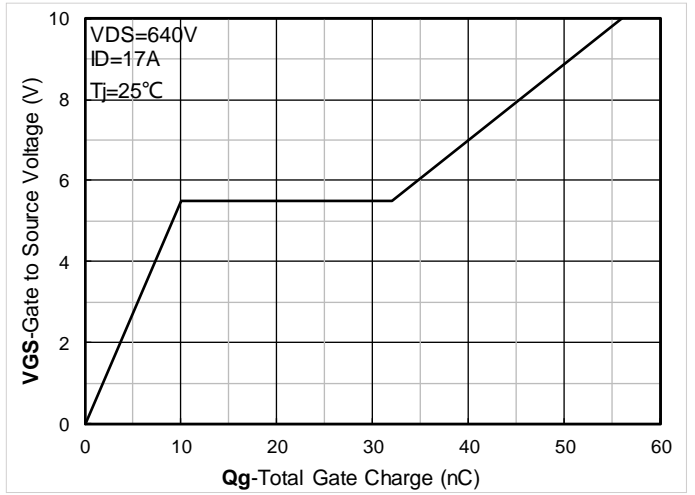

Figure4. Gate Charge

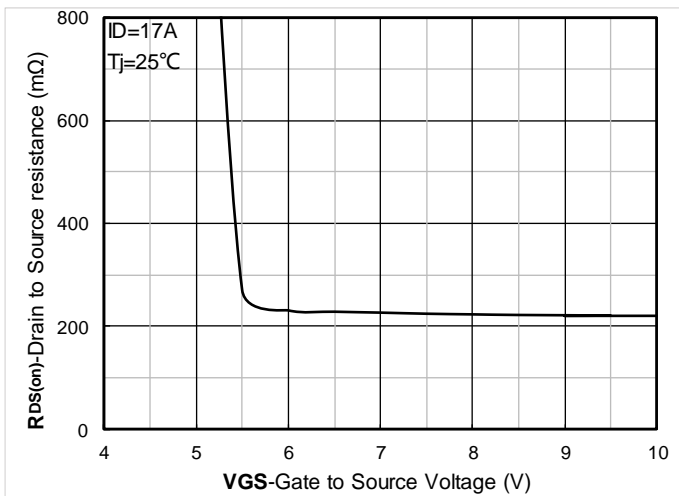

Figure5. On-Resistance vs Gate to Source Voltage

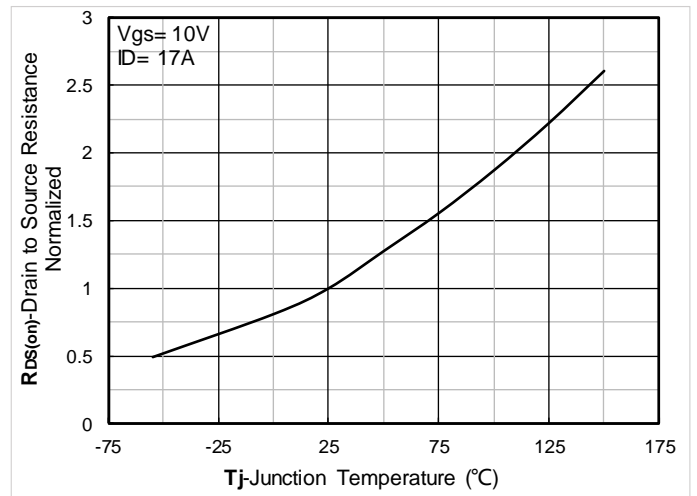

Figure6. Normalized On-Resistance



# YJB17C80HJ

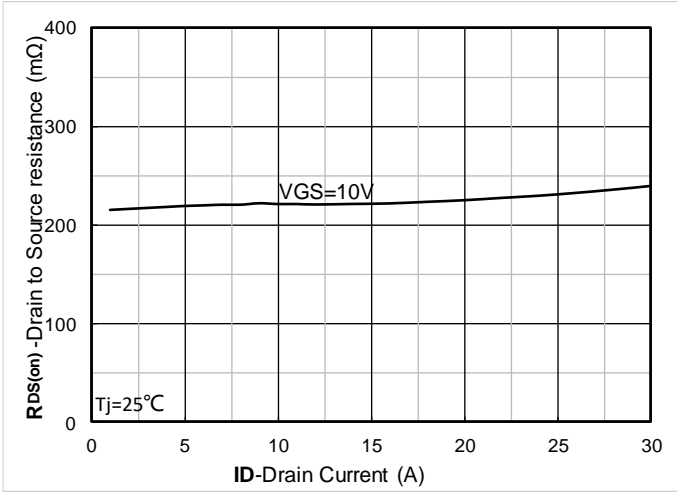

Figure7. RDS(on) VS Drain Current

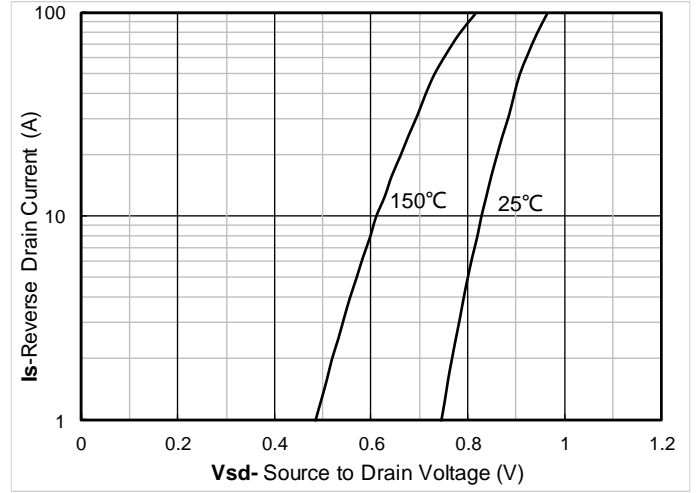

Figure8. Forward characteristics of reverse diode

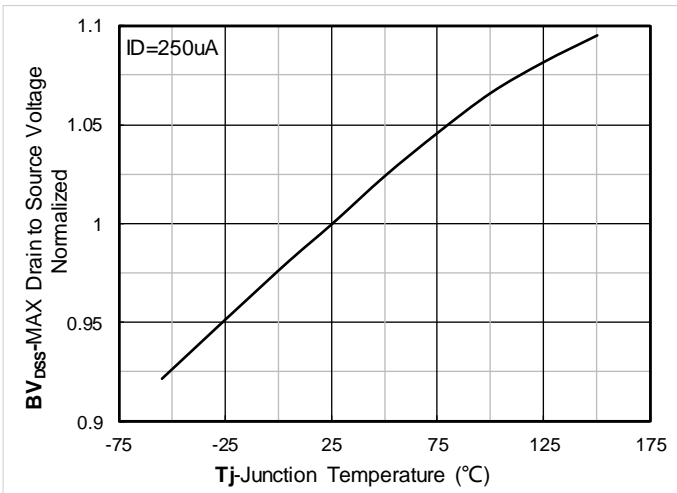

Figure9. Normalized breakdown voltage

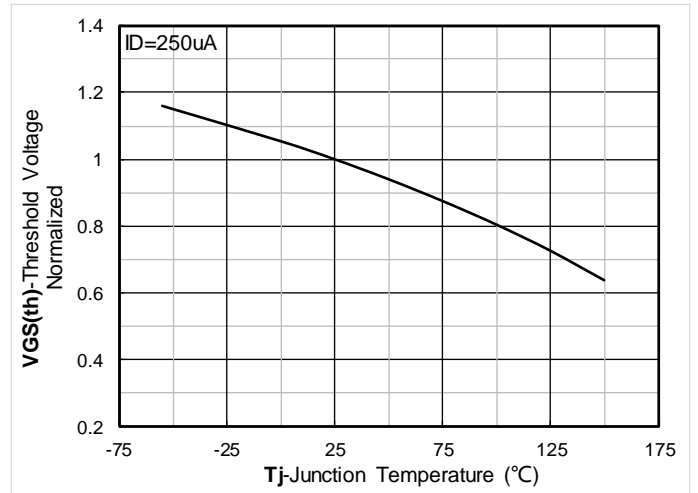

Figure10. Normalized Threshold voltage

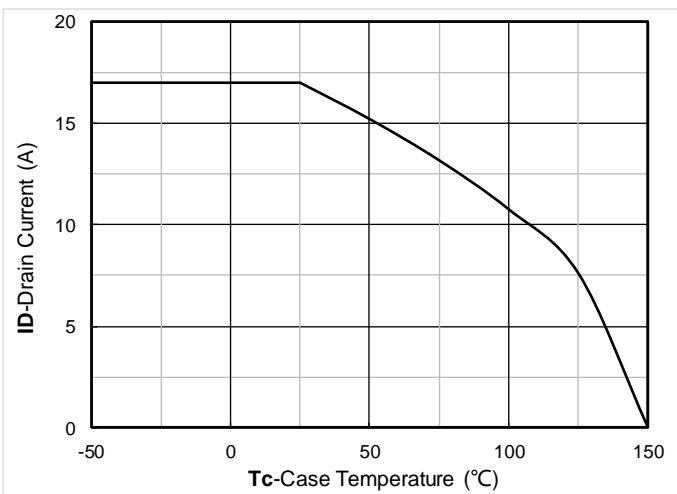

Figure11. Current dissipation

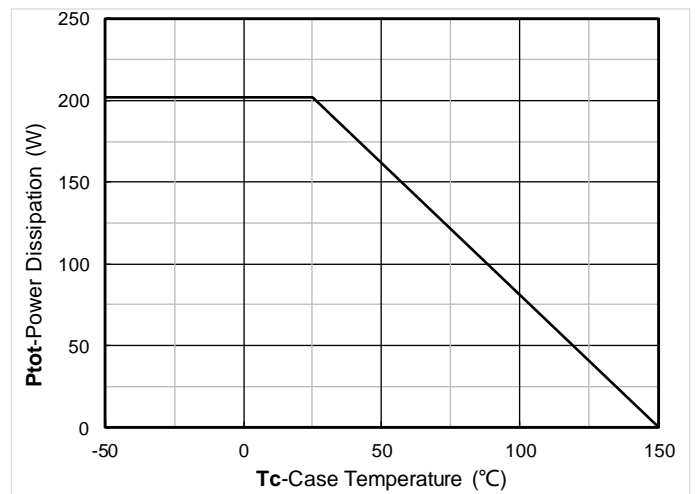

Figure12. Power dissipation



# YJB17C80HJ

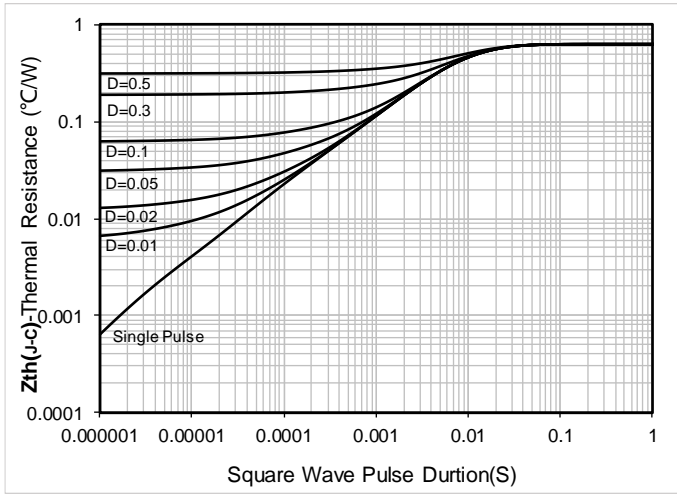

Figure13. Maximum Transient Thermal Impedance

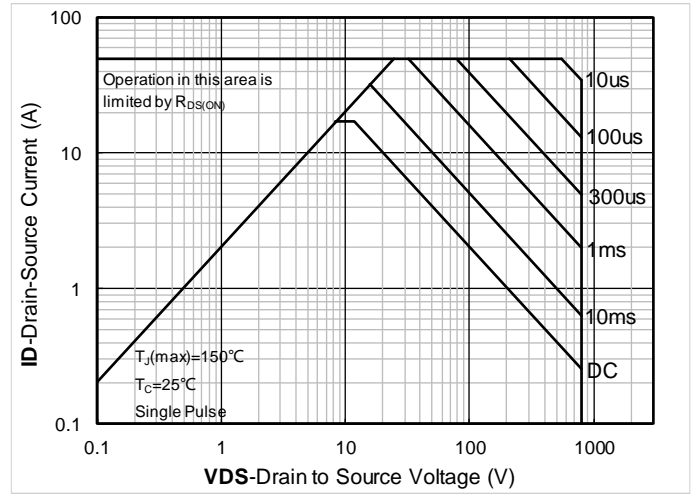
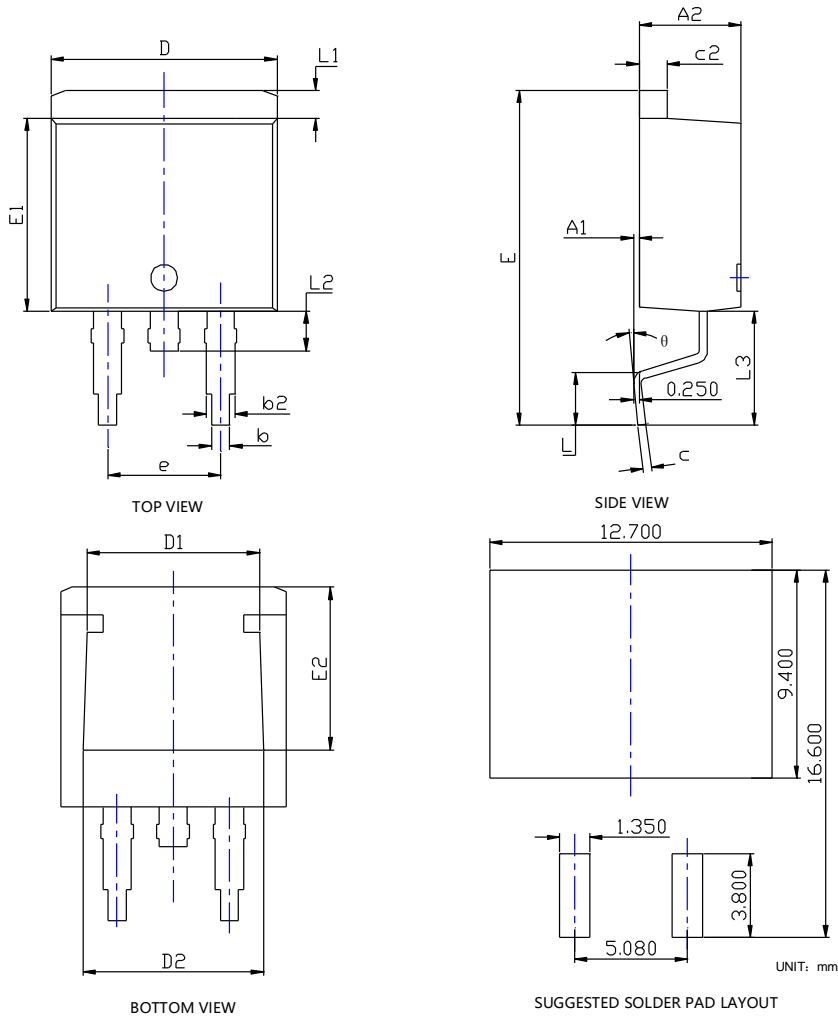

Figure14. Safe Operation Area



# YJB17C80HJ

## ■TO-263-HY Package information



SYMBOL	DIMENSIONS					
	INCHES			Millimeter		
	MIN.	NOM.	MAX.	MIN.	NOM.	MAX.
A1	0.000	---	0.010	0.000	---	0.250
A2	0.174	0.180	0.186	4.430	4.580	4.730
b	0.028	0.032	0.036	0.720	0.820	0.920
b2	0.046	0.050	0.054	1.180	1.280	1.380
c	0.013	0.015	0.018	0.330	0.390	0.450
c2	0.048	0.050	0.053	1.220	1.280	1.340
D	0.394	0.400	0.406	10.000	10.150	10.300
D1	0.295	0.307	0.319	7.500	7.800	8.100
D2	0.303	0.315	0.327	7.700	8.000	8.300
E	0.571	0.591	0.610	14.500	15.000	15.500
E1	0.337	0.341	0.348	8.550	8.700	8.850
E2	0.276	0.287	0.299	7.000	7.300	7.600
e	0.200BSC			5.080BSC		
L	0.070	---	0.110	1.790	---	2.790
L1	0.044	---	0.056	1.120	---	1.420
L2	0.030	---	0.070	0.770	---	1.770
L3	0.197REF			5.000REF		
θ	0°	---	8°	0°	---	8°

### NOTE:

- 1.PACKAGE BODY SIZES EXCLUDE MOLD FLASH AND GATE BURRS.
- 2.TOLERANCE 0.1mm UNLESS OTHERWISE SPECIFIED.
- 3.THE PAD LAYOUT IS FOR REFERENCE PURPOSES ONLY.



## YJB17C80HJ

---

### Disclaimer

The information presented in this document is for reference only. Yangzhou Yangjie Electronic Technology Co., Ltd. reserves the right to make changes without notice for the specification of the products displayed herein to improve reliability, function or design or otherwise.

The product listed herein is designed to be used with ordinary electronic equipment or devices, and not designed to be used with equipment or devices which require high level of reliability and the malfunction of which would directly endanger human life (such as medical instruments, transportation equipment, aerospace machinery, nuclear-reactor controllers, fuel controllers and other safety devices), Yangjie or anyone on its behalf, assumes no responsibility or liability for any damages resulting from such improper use of sale.

This publication supersedes & replaces all information previously supplied. For additional information, please visit our website <http://www.21yangjie.com> , or consult your nearest Yangjie's sales office for further assistance.