

NPN General Purpose Amplifier

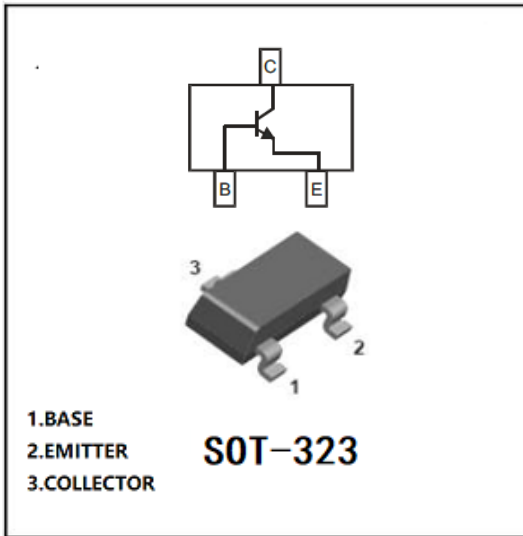

Features

- Epoxy meets UL-94 V-0 flammability rating
- Halogen free available upon request by adding suffix "HF"
- Moisture Sensitivity Level 1
- High Conductance
- Surface Mount Package Ideally Suited for Automatic Insertion

Mechanical Data

- **Package:** SOT-323
Molding compound meets UL 94 V-0 flammability rating, RoHS-compliant, halogen-free
- **Terminals:** Tin plated leads, solderable per J-STD-002 and JESD22-B102
- **Marking:**

2SC4081-Q	BQ
2SC4081-R	BR
2SC4081-S	BS

■Maximum Ratings (Ta=25°C unless otherwise noted)

Item	Symbol	Rating	Unit
Collector-Base Voltage	V_{CBO}	60	V
Collector-Emitter Voltage	V_{CEO}	50	V
Emitter-Base Voltage	V_{EBO}	7	V
Collector Current	I_C	150	mA
Collector Power Dissipation	P_C	200	mW
Operation Junction Temperature	T_J	150	°C
Storage Temperature	T_{stg}	-55 to +150	°C

■Ordering Information (Example)

PREFERRED P/N	PACKING CODE	UNIT WEIGHT(g)	MINIMUM PACKAGE(pcs)	INNER BOX QUANTITY(pcs)	OUTER CARTON QUANTITY(pcs)	DELIVERY MODE
2SC4081	F2	Approximate 0.005	3000	30000	120000	7" reel



■ Electrical Characteristics (Ta=25°C Unless otherwise specified)

Item	Symbol	Unit	Conditions	Min	TYP	Max
Collector-base breakdown voltage	V_{CBO}	V	$I_C=50\mu A, I_E=0$	60		
Collector-emitter breakdown voltage	V_{CEO}	V	$I_C=1mA, I_B=0$	50		
Emitter-base breakdown voltage	V_{EBO}	V	$I_E=50\mu A, I_C=0$	7		
Collector-base cut-off current	I_{CBO}	μA	$V_{CB}=60V, I_E=0$			0.1
Emitter-base cut-off current	I_{EBO}	μA	$V_{EB}=7V, I_C=0$			0.1
DC current gain	h_{FE}		$V_{CE}=6V, I_C=1mA$	120		560
Collector-emitter saturation voltage	$V_{CE(sat)}$	V	$I_C=50mA, I_B=5mA$			0.4
Output Capacitance	C_{ob}	V	$V_{CB}=12V, I_E=0, f=1MHz$		3	
Transition frequency	f_T	MHz	$V_{CE}=12V, I_C=2mA, f=30MHz$		180	

■ Classification of h_{FE}

Rank	2SC4081-Q	2SC4081-R	2SC4081-S
Range	120-270	180-390	270-560

■ Characteristics(Typical)

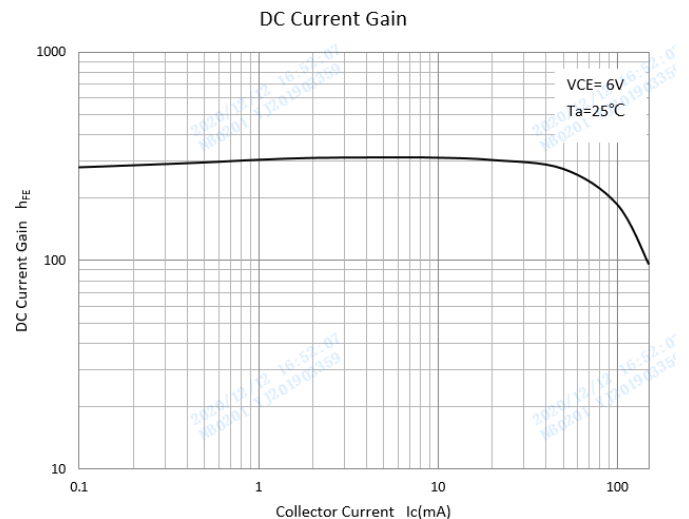
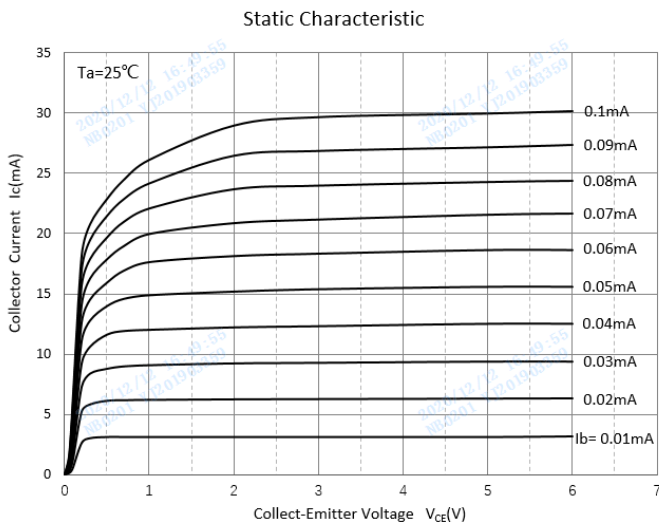



Collector-Emitter Saturation Voltage

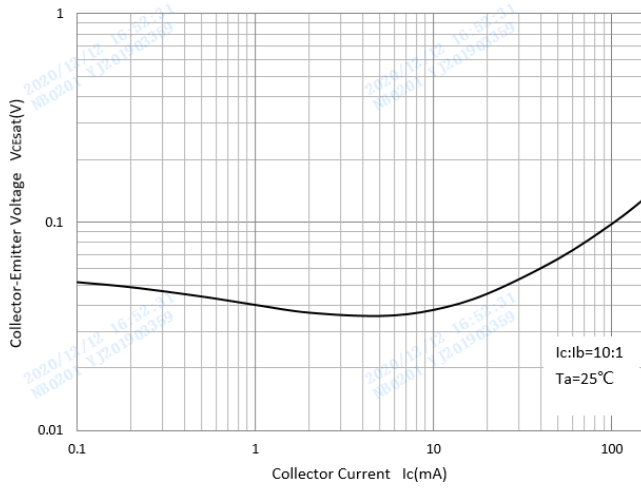

Base-Emitter Saturation Voltage

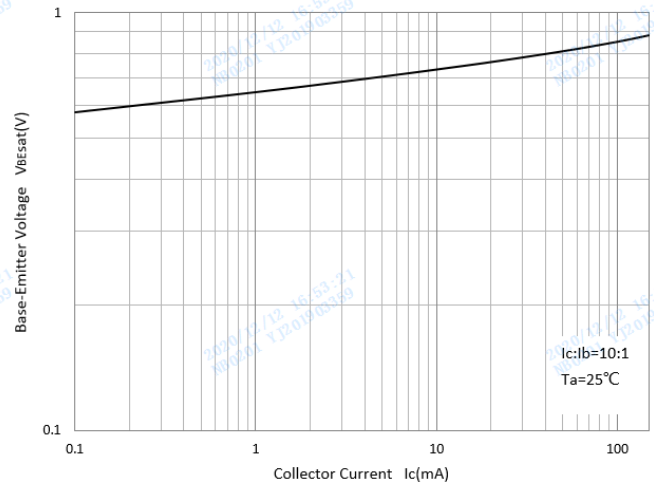

Base-Emitter On Voltage

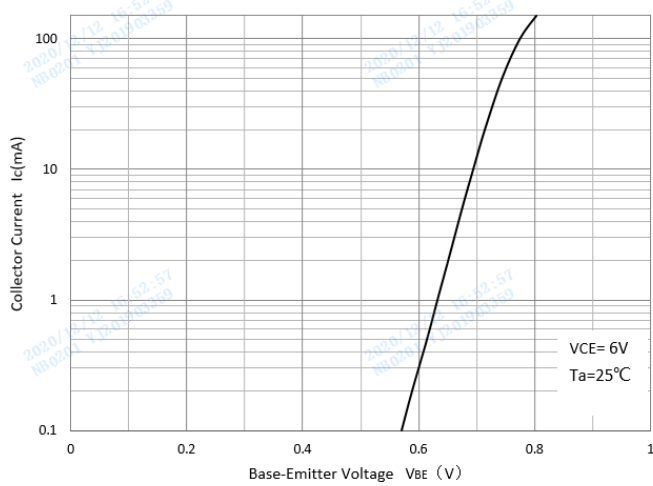

$C_{ob}/C_{ib}-V_{CB}/V_{EB}$

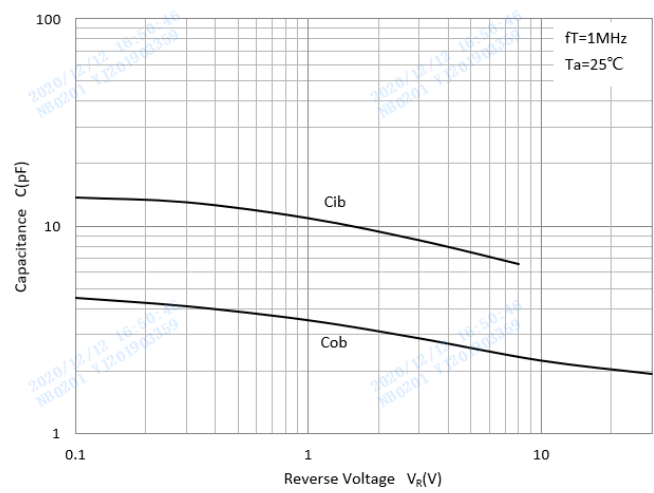

Collector Power Derating Curve

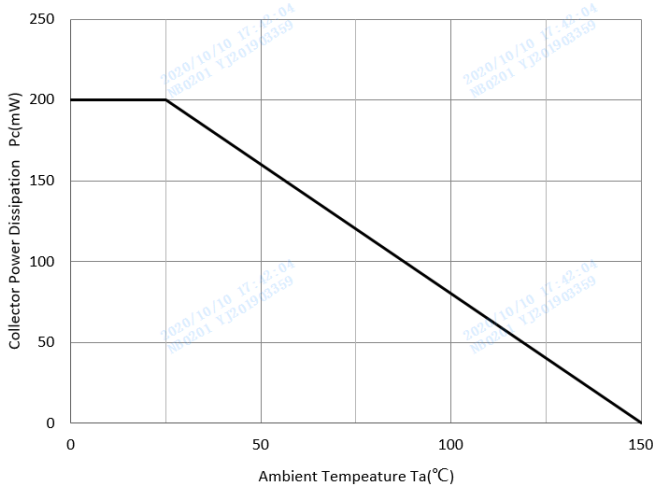

■ SOT-323 Package Outline Dimensions

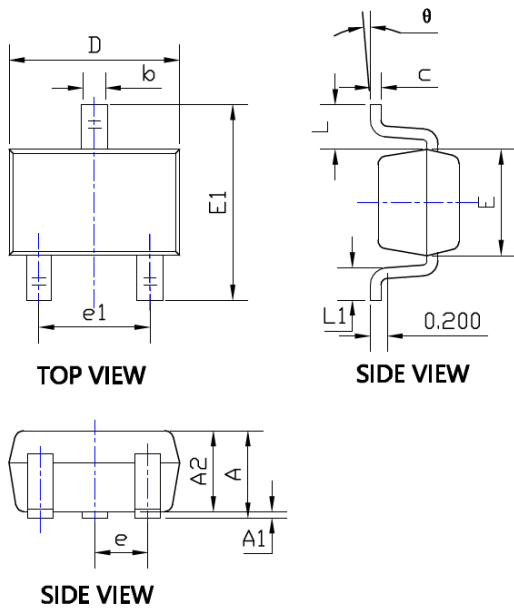

SYMBOL	DIMENSIONS			
	INCHES		Millimeter	
	MIN.	MAX.	MIN.	MAX.
A	0.035	0.043	0.900	1.100
A1	0.000	0.004	0.000	0.100
A2	0.035	0.039	0.900	1.000
b	0.006	0.016	0.150	0.400
c	0.004	0.010	0.100	0.250
D	0.071	0.087	1.800	2.200
E	0.045	0.053	1.150	1.350
E1	0.085	0.096	2.150	2.450
e	0.026TYP		0.650TYP	
e1	0.047	0.055	1.200	1.400
L	0.021REF		0.525REF	
L1	0.010	0.018	0.260	0.460
θ	0°	8°	0°	8°

■ SOT-323 Soldering Footprint

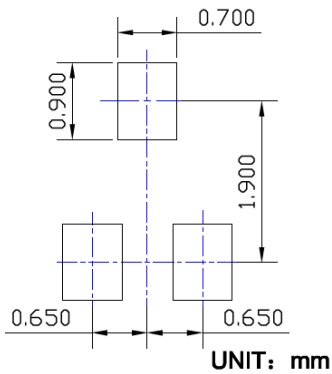



Disclaimer

The information presented in this document is for reference only. Yangzhou Yangjie Electronic Technology Co., Ltd. reserves the right to make changes without notice for the specification of the products displayed herein to improve reliability, function or design or otherwise.

The product listed herein is designed to be used with ordinary electronic equipment or devices, and not designed to be used with equipment or devices which require high level of reliability and the malfunction of which would directly endanger human life (such as medical instruments, transportation equipment, aerospace machinery, nuclear-reactor controllers, fuel controllers and other safety devices), Yangjie or anyone on its behalf, assumes no responsibility or liability for any damages resulting from such improper use of sale.

This publication supersedes & replaces all information previously supplied. For additional information, please visit our website [http:// www.21yangjie.com](http://www.21yangjie.com) , or consult your nearest Yangjie's sales office for further assistance.